



## LJMU Research Online

Rajarathinam, K, Gomm, JB, Yu, DL and Abdelhadi, AS

**PID controller tuning for a multivariable glass furnace process by genetic algorithm**

<http://researchonline.ljmu.ac.uk/4075/>

### Article

**Citation** (please note it is advisable to refer to the publisher's version if you intend to cite from this work)

**Rajarathinam, K, Gomm, JB, Yu, DL and Abdelhadi, AS (2016) PID controller tuning for a multivariable glass furnace process by genetic algorithm. International Journal of Automation and Computing, 13 (1). pp. 64-72. ISSN 1476-8186**

LJMU has developed **LJMU Research Online** for users to access the research output of the University more effectively. Copyright © and Moral Rights for the papers on this site are retained by the individual authors and/or other copyright owners. Users may download and/or print one copy of any article(s) in LJMU Research Online to facilitate their private study or for non-commercial research. You may not engage in further distribution of the material or use it for any profit-making activities or any commercial gain.

The version presented here may differ from the published version or from the version of the record. Please see the repository URL above for details on accessing the published version and note that access may require a subscription.

For more information please contact [researchonline@ljmu.ac.uk](mailto:researchonline@ljmu.ac.uk)

<http://researchonline.ljmu.ac.uk/>



**PID Controller Tuning for a Multivariable Glass Furnace Process by Genetic Algorithm**

Journal:	<i>International Journal of Automation and Computing</i>
Manuscript ID:	IJAC-2015-02-097
Manuscript Type:	Regular Paper
Date Submitted by the Author:	09-Feb-2015
Complete List of Authors:	Gomm, Barry; Liverpool John Moores University, School of Engineering Rajarathinam, Kumaran; Liverpool John Moores University, School of Engineering Yu, Ding-Li; Liverpool John Moores University, Engineering Abdelhadi, Ahmed; Liverpool John Moores University, School of Engineering
Keywords:	process control, genetic algorithms (GA), optimisation and simulation, multivariable control
Specialty/Area of Expertise:	Genetic algorithms < Artificial intelligence, Automatic control

SCHOLARONE™  
Manuscripts

# PID Controller Tuning for a Multivariable Glass Furnace Process by Genetic Algorithm

Kumaran Rajarathinam    J. Barry Gomm    DingLi Yu    Ahmed Saad Abdelhadi

Mechanical Engineering and Materials Research Centre (MEMARC), Control Systems Group, School of Engineering,  
Liverpool John Moores University, Byrom Street, Liverpool, L3 3AF, UK

**Abstract:** Standard genetic algorithms (SGAs) are investigated to optimise the discrete-time PID controller parameters by three tuning approaches for a multivariable glass furnace process with loop interaction. Initially, SGAs are used to identify control oriented models of the plant which are subsequently used for controller optimisation. An individual tuning approach without loop interaction is considered first to categorise the genetic operators, cost functions and improve searching boundaries to attain the desired performance criteria. The second tuning approach considers controller parameters optimisation with loop interaction and individual cost functions. While, the third tuning approach utilises a modified cost function which includes the total effect of both controlled variables, glass temperature and excess oxygen. This modified cost function is shown to exhibit improved control robustness and disturbance rejection under loop interaction.

**Keywords:** genetic algorithms, control optimisation, decentralised control, PID control, modified cost function, multivariable process, loop interaction.

## 1 Introduction

Glass manufacturing processes have very long dynamic response times and are complex processes with high energy usage. Especially, large furnaces with multiple port burners cause the glass manufacturing industries to consume high energies in glass production. Most glass industries are operating at maximum daily throughput to fulfil the market requirement. Therefore, glass furnace operations are facing great challenges in reduction of fuel consumption by applying well tuned control strategies. Apart from high energy consumption, undesirable emissions from glass industries are another setback to consider as the entire world is greatly concerned about green house effects. Tight environmental regulations are now applied to reduce gases and particles that are undesirable emissions associated with burning fossil fuels.

Generally, the glass industries are operating within the emission guideline which is regulated by environmental agencies [1]. Thus, most glass industries are not emphasising on continuous monitoring and control strategies for emissions. At maximum operating conditions, the likelihood of producing undesirable emission is high. If there is any occurrence of sudden undesirable disturbances, this can result in more problems for existing furnaces which may be already operating in poor thermal conditions around the world. The control of excess oxygen emissions, as well as glass temperature, is therefore also considered in this paper.

For such a complex multivariable process, a decentralised control strategy is generally applied and has always been in the attention of many researchers for developing a precise control strategy to enhance the performance of multivariable processes. However, difficulties are encountered in designing the decentralised control due to the loop interactions.

A literature search reveals that there are several classified

tuning methods suggested to tune decentralised controllers for multivariable processes such as detuning [2], sequential design [3], independent design [4] and iterative [5] methods. These tuning methods have achieved a certain degree of success in the design approach. However, these tuning methods do exhibit weaknesses and can suffer in compensating the couplings between loop interactions of a multivariable system. To improve the compensation of loop interactions, the effective open-loop method (EOP) was introduced [6]. The EOP method considers all other loop interactions while adapting the  $i$ -th control parameters for the  $i$ -th EOP. But, the EOP method produces model approximation error due to mathematical complications as the model dimensions are increased. Thus, the EOP method is mainly applicable for low dimension models. Another successful approach is that of relay auto-tuning, which is a combination of single loop relay auto-tuning and the sequential tuning method [7]. This method appears to perform well, but a multivariable system with large multiple dead times exhibits poor performance. In recent years, to improve the entire control performance and robust stability, a systematic approach based on the generalised IMC-PID design method [8] and the reduced effective transfer function (RETF) by inverse response behaviour method [9] have been introduced for multivariable processes. But, both methods involve a complex mathematical approach to design the decentralised controllers. In general, a question always arises about the wellness of control optimisation and the flexibility due to the application constraints by these design methods.

Standard genetic algorithms (SGAs) are a global search method by genetics evolution with higher performance in optimisation over traditional methods [10, 19]. Due to its superior self-adjustable ability, SGAs have been applied extensively in tuning the PID parameters for SISO systems [11], curve fitting [12] and fuzzy optimisation [13]. On the other hand, application to multiple-input multiple-output (MIMO) systems is still an open research topic for optimising control parameters by SGAs. A promising decentralised

Manuscript received date; revised date

2

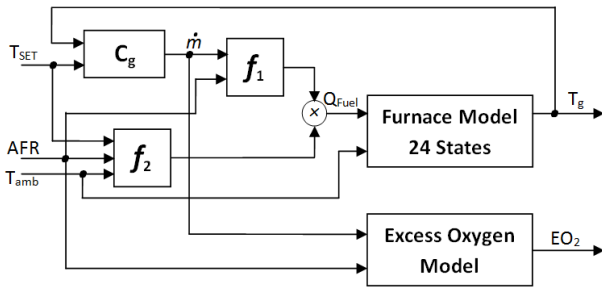

Figure 1 Block diagram of realistic multivariable glass furnace process model

controller by SGAs was proposed for a multivariable process [14]. The controller performance was defined by closed-loop response in terms of time-domain bounds for both reference following and loop interactions. An integrity theorem with SGAs to enhance the closed-loop system stability when certain loops are failing or breaking down was proposed [15]. Recently, improved convergence of genetic algorithms was achieved by introducing the multi-objective evolutionary algorithm (MOEA) which combines two fitness assignments methods; global rank and dominance rank [16].

This paper investigates the potential of SGAs in optimising the discrete-time PID controller parameters in a decentralised control scheme for a multivariable glass furnace. The structure of this paper is as follows; first, an introduction is given about the considered multivariable glass furnace process and models used for the controller optimisation studies. Second, the approach to optimisation by SGAs of discrete PID controller parameters is presented, with considerations to boundary constraints and particular cost functions. Third, investigations are presented of loop interaction effects and control robustness for the multivariable glass furnace, with controllers optimised by three SGAs tuning approaches. The proposed methods are developed and tested in simulations based on Matlab/Simulink models.

## 2 The Multivariable Glass Furnace Process and Modelling

Fig. 1 illustrates the block diagram of the realistic multivariable glass furnace considered in this research, which consists of a 24 state-space furnace model with feedback loop and excess oxygen model.  $f_1$  and  $f_2$  are algebraic expressions,  $f_1$  includes controller output and saturation,  $f_2$  includes specific heat (Cp) and lower heat value (LHV) for determining the combustion energy, TSET is primary temperature setting, AFR is air-fuel ratio, Tamb is ambient temperature,  $\dot{m}$  is fuel flow in mass,  $T_g$  is glass temperature and  $EO_2$  is excess oxygen.

The realistic glass furnace model that is identified and applied for further research here is representing a real plant combustion chamber from Fenton Art Glass Company, USA [17]. The furnace model is an extended research work by Holladay [18] using a radiative zone method to develop the 24 state space variables (zones) model. The linearised en-

International Journal of Automation and Computing X(X), X X

ergy balance equations are applied and modified with respect to the 24 state variables for each zone corresponding to temperatures. For example, the energy balance equation of combustion zone  $\alpha 1$  can be written as,

$$C a_{\alpha 1} \frac{dT a_{\alpha 1}}{dt} = Q a_{\alpha 1} = Q b w_{\alpha 1} + Q c_{\alpha 1} + Q s w_{\alpha 1} + Q a_{\alpha 2} + Q g_{\beta 1} + Q g_{\beta 2} + Q g_{\chi 1} + Q g_{\chi 2} + Q g_{\delta 1} + Q g_{\delta 2} + Q i_n \quad (1)$$

A literature survey reveals that there is no  $EO_2$  realistic model for a glass furnace available for research. The realistic  $EO_2$  model designed for research here was developed using collected numerical data from an industrial furnace by an open-loop step response technique. SGAs were applied for identification of a higher order transfer function (3rd order) as a realistic model for  $EO_2$ , and control oriented models for both  $T_g$  and  $EO_2$  for control optimisation. The identified transfer functions by SGAs are;

For  $EO_2$  Realistic Model,

$$\frac{\Delta EO_2(s)}{\Delta AFR(s)} = \frac{1.613}{50.3s^3 + 149.6s^2 + 142.7s + 1} e^{-173s} \quad (2)$$

For  $EO_2$  Control Oriented Model,

$$\frac{\Delta EO_2(s)}{\Delta AFR(s)} = G_{EO_2}(s) = \frac{1.6}{150s + 1} e^{-174s} \quad (3)$$

For Glass Furnace Temperature Control Oriented Model,

$$\Delta T_g(s) = G_{T_g 1}(s) \Delta \dot{m}(s) + G_{T_g 2}(s) \Delta T_{SET}(s) = \frac{4488.4}{1.992e5s + 1} \Delta \dot{m}(s) + \frac{-0.9834}{1.992e5s + 1} \Delta T_{SET}(s) \quad (4)$$

According to the collected data of  $EO_2$ , the model is designed based on step input of air-fuel ratio (AFR ratio is 1:17.2 in mass). Any numerical value representation of fuel in kg/s is in ratio of 1. Thus, there will be no affect on the  $EO_2$  when  $\dot{m}$  is changed. However, any variation in air-fuel ratio will affect the outputs of  $f_1$  and  $f_2$  which leads directly to changes in  $\dot{m}$  and hence,  $T_g$ . Therefore, the multivariable glass furnace process has single loop interaction from AFR to  $T_g$  under closed-loop influences. The identified control oriented model of the interaction was,

$$\frac{\Delta T_g(s)}{\Delta AFR(s)} = G_{AFR}(s) = \frac{-61.5}{2e5s + 1} \quad (5)$$

The dynamics of the glass furnace process are represented by the following low order  $2 \times 3$  transfer function matrix which is used for controller optimisation.

$$\begin{bmatrix} \Delta T_g(s) \\ \Delta EO_2(s) \end{bmatrix} = \begin{bmatrix} G_{T_g 1} & G_{T_g 2} & G_{AFR} \\ 0 & 0 & G_{EO_2} \end{bmatrix} \begin{bmatrix} \Delta \dot{m}(s) \\ \Delta T_{SET}(s) \\ \Delta AFR(s) \end{bmatrix} \quad (6)$$

For a more complete control realisation of the  $EO_2$  process, the realistic model transfer function (2) is associated with an AFR conversion model and  $EO_2$  look-up table as illustrated in Fig. 2. The AFR conversion model was particularly designed to convert the real value of AFR(mass) to respective AFR(volumetric) based on the methane gas law.

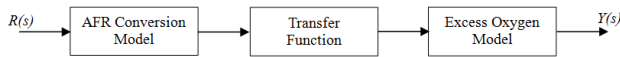
Figure 2 Block diagram of complete realised  $EO_2$  model

The transfer function (2) and AFR conversion model are linear. But, the  $EO_2$  look-up table exhibits some nonlinearity effects due to the methane chemical relationship between the stoichiometric AFR(volumetric) input and  $EO_2(\%)$  output.

### 3 Discrete PID Parameters Optimisation by SGAs

In general, a classical PID controller can be described as an input-output relation expressed as,

$$u(t) = K_c \left( e(t) + \frac{1}{T_i} \int e(t) dt + T_d \frac{de(t)}{dt} \right) \quad (7)$$

where  $u$  is the control signal,  $e$  is the error signal, and  $K_c$ ,  $T_i$  and  $T_d$  denote the proportional gain, the integral gain and derivative gain, respectively. By using finite difference approximations, (7) is expressed to its discrete equivalent in positional form. For more accurate approximations, the trapezoidal and backward rules are applied here to develop discrete expressions for the integral and derivative terms, respectively ( $K_I = 1/T_i$ ),

$$G_c(z) = \frac{U(z)}{E(z)} = K_c \left( 1 + K_I \frac{T}{2} \frac{(z+1)}{(z-1)} + T_d \frac{1}{T} \frac{(z-1)}{z} \right) \quad (8)$$

#### 3.1 Performance Criteria Formulation

The performance criteria for both  $T_g$  and  $EO_2$  are formulated individually under closed-loop SISO control based on the following desired response characteristics.

- For  $T_g$ ; Overshoot  $\leq 2\%$ , Settling time ( $t_s$ )  $\approx 5$ hrs.
- For  $EO_2$ ; Overshoot  $\leq 2\%$ , Settling time ( $t_s$ )  $\approx 7$ min.
- For both variables; zero steady state error to a constant set point

#### 3.2 SGAs Configuration

The SGAs approach used for optimisation of the PID controller parameters is shown in Fig. 3. As illustrated in the flowchart of the SGAs, at initial state, the chromosomes of an array of variable values to be optimised are defined as:

$$\text{Chromosome} = \underbrace{\{(K_c, K_I, T_d)\}}_{T_g}, \underbrace{\{(K_c, K_I, T_d)\}}_{EO_2} \quad (9)$$

The binary coding was selected to encode the discrete controller parameters into binary strings to generate the initial population randomly in the beginning. The length of each chromosome (Lind) is determined based on the binary precision or resolution:

$$\text{res}_j = \frac{(b_j - a_j)}{2^{m_j} - 1} \quad (10)$$

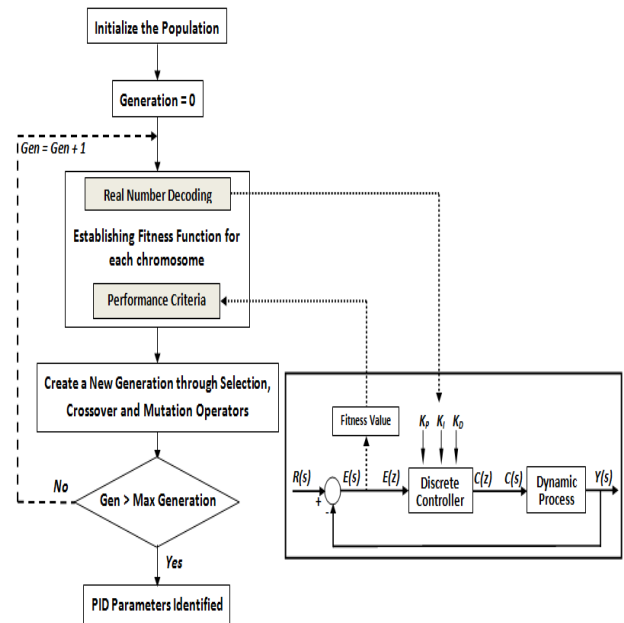

Figure 3 Flow chart of control optimisation by SGAs

where  $m_j$  is the number of bits,  $b_j$  is the upper boundary and  $a_j$  is the lower boundary of each individual chromosome's searching parameter. Each chromosome's binary string is converted into an associated real value of PID parameters to propagate to the discrete PID controller. The decoding process into a real value is done as:

$$x_j = a_j + \text{Dec} \times \frac{(b_j - a_j)}{2^{m_j} - 1} \quad (11)$$

where  $x_j$  is the respective real value of the chromosome's search parameter and Dec is the decimal value of the respective binary string. A complete simulated system response of each PID set and its initial fitness value is evaluated by using a defined objective function.

According to the chromosome's fitness value by a defined objective function, a new generation (offspring) is produced by the process of genetic operators. The genetic operators manipulate the binary strings of the chromosome directly, by means of selection rate ( $S_{rate}$ ), crossover rate ( $X_{rate}$ ) and mutation rate  $M_{rate}$  to produce fitter chromosomes for the next generation. After completion of the genetic operator process, the new set of binary strings for each chromosome in the population is required to be decoded into real values and propagated again to the discrete PID controller to evaluate for a new fitness value. This process is sequentially repeated until a maximum number of generations, where the optimal fitness is attained. Due to no previous information available for genetic operator values for both  $T_g$  and  $EO_2$  control optimisation, several experiments were conducted where variations of the genetic operator values were tested individually for enhancing the searching mechanism. Table 1 illustrates the selected genetic operator parameters for both  $T_g$  and  $EO_2$ .

Table 1 Genetic Operators of  $T_g$  and  $EO_2$ 

Genetic Operators	$T_g$ (K)	$EO_2$ (%)
No. of individuals	50	50
Max. No. of Generation	30	50
Generation Gap	0.6	0.7
Precision of Binary Rep.	6	6
Selection	SUS	SUS
Crossover	Single Point, 0.6	Single Point, 0.7
Mutation	Binary Rep., 0.6/Lind	Binary Rep., 0.6/Lind

### 3.3 Objective Function and Boundary Constraint Formulation

The control oriented models of both  $T_g$  and  $EO_2$  were used individually to identify the optimum objective function and searching boundaries to achieve the performance criteria. In the first attempt initial guesses were made for the search boundaries in the SGAs. Improved boundary constraints were subsequently introduced. For better selection of improved boundary values, conventional tuning methods (Ziegler-Nichols and Direct Synthesis) were analysed to identify PID values. With these identified PID values, the  $b_j$  and  $a_j$  were adjusted accordingly to ensure an optimal solution for the desired response characteristics.

Two objective functions, integral absolute error (IAE) and integral squared error (ISE),

$$J_i (IAE) = \sum_{k=0}^{k=max} |e(k)| \quad (12)$$

$$J_i (ISE) = \sum_{k=0}^{k=max} e^2(k) \quad (13)$$

were used to compare and improve the set-point error for  $EO_2$ . Fig. 4 and Table 2 illustrates that the SGAs with parameter vectors of improved bound PID,  $K_c \in [0, 1]$ ,  $K_I \in [0, 0.01]$ ,  $T_d \in [0, 50]$ , of  $EO_2$  has better dynamic response and higher degree of accuracy while reducing the performance criterion by adapting the fitness value. Initial optimisation of PID parameters by conventional techniques provides a better suggestion of improved bound ranges than assigning the ranges randomly or arbitrarily. By limiting the  $b_j$  of  $K_c$ , the SGA consolidates well within the boundary constraints for  $K_I$  and  $T_d$  to converge to the global minimum.

However, Fig. 5 and Table 3 illustrates, an overshoot of 10% (1555 K) occurred in the transient response with long settling time of 30hrs for  $T_g$  with improved boundaries. SGAs optimised close to the  $b_j$  to attain the desired response characteristics, but failed to achieve a global minimum. To enhance the searching mechanism for the control parameters and achieve a global minimum, a modified cost function is applied. The weighting factor  $\lambda$  applied to the process input term is added to the cost function to reduce the fast rising effect of the transient response. The modified cost function applied for  $T_g$  is given by the relation,

$$J_i (IAE + \lambda ISU) = \sum_{k=0}^{k=max} |Tg(k) - 1550| + \lambda u^2(k) \quad (14)$$

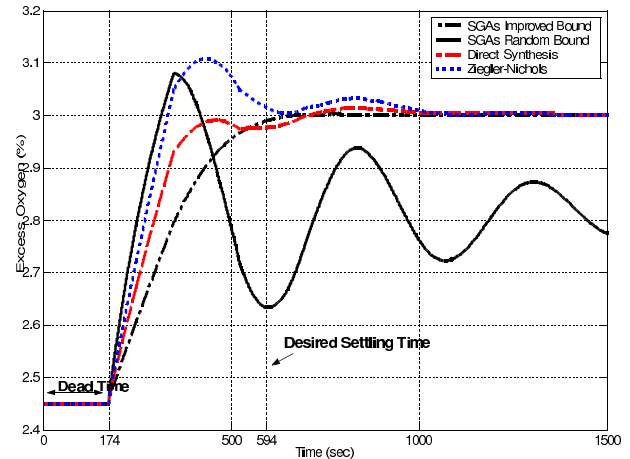

Figure 4 SGAs random and improved boundaries of  $EO_2$  responses with conventional techniques.

where  $k$  is the sampling number and  $u$  is the controller output. The selection of optimal value of  $\lambda$  is done by trial and error technique by varying  $\lambda$  in the range [100, 1000]. The weighting factor associated with the desired response characteristics was set to  $\lambda = 400$  to give more emphasis to the set point tracking objectives.

The simulation results in Fig. 5 and Table 3 illustrate that the SGA with modified cost function,  $IAE + \lambda ISU$  (14), has a higher level of optimisation mechanism and better dynamic response than the improved searching bound alone. Application of  $\lambda$  with ISU has suppressed the larger overshoot behaviour of the glass temperature response by smoothing the controller output. Overall desired response characteristics, which are reduction of set-point error, overshoot and settling time, are achieved for  $T_g$  with the  $IAE + \lambda ISU$  cost function.

## 4 Simulation Results of Decentralised Control Strategies by SGAs

The optimisation of discrete decentralised control strategies are analysed by three SGAs tuning approaches, associated with the 2x2 control oriented multivariable glass furnace model as illustrated in Fig. 6. The three SGAs tuning approaches are applied in closed-loop step input tests. The three tuning approaches are:

**SGAs-1** : the discrete PID values of both  $T_g$  and  $EO_2$  are optimised individually with their respective closed-

Table 2 PID parameters for  $EO_2$  by different tuning methods

Tuning Method	$K_c$	$K_I$	$T_d$	ISE	IAE	$t_s$ (2%)
Ziegler-Nichols	1.38	0.0038	65.88	103.8	268.6	14min
Direct Synthesis	1.137	0.0034	74	92.84	231.7	14.5min
Random Bound SGAs	2	0	36.67	119.8	355.6	35.8 min
Improved Bound SGAs	0.7685	0.0043	32.27	83.26	187.7	7.1min

Table 3 PID parameters for  $T_g$  by different tuning methods

Tuning Method	$K_c$	$K_I$	$T_d$	Set-point Error	$t_s$ (2%)
Direct Synthesis	2.235e-3	5.15e-5	3.563	1.981e5	40hrs
Improved Bound SGA	3.675e-3	2.54e-5	6.322	8.438e4	30hrs
Weighting Factor SGA	9.863e-3	9.46e-6	7.358	7.029e4	4.9hrs

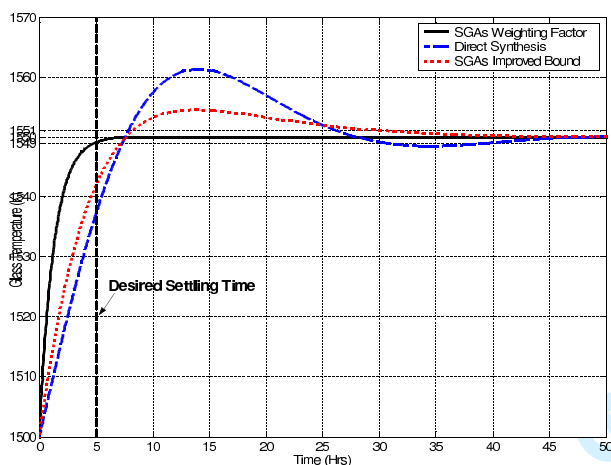

Figure 5 SGAs improved boundaries and  $\lambda$ ISU of  $T_g$  responses with conventional techniques.

loop control oriented model (independently) without loop interactions as discussed in section 3.3.

**SGAs-2** : the discrete PID values of both  $T_g$  and  $EO_2$  are optimised individually with their respective closed-loop control oriented model with loop interaction. ( $C_1(z)$  is optimised with respective cost function;  $T_{SET} = 1500K \rightarrow 1550K$ ;  $EO_{2(Ref)}$  is constant (2.45%);  $C_2(z) =$  default value; and vice-versa).

**SGAs-3** : the discrete PID value of both  $T_g$  and  $EO_2$  are optimised together by multivariable closed-loop control oriented model with loop interaction. The optimised cost function is modified to include the total effect of  $T_g$  and  $EO_2$  by adding the individual cost functions for both variables for each test as shown in (15). ( $C_1(z)$  and  $C_2(z)$  are optimised with modified cost function:  $T_{SET} = 1500K \rightarrow 1550K$  at  $EO_2 =$  steady-state;  $EO_{2(Ref)} = 2.45\% \rightarrow 3\%$  at  $T_{SET} =$  steady-state (1550K).

$$\begin{aligned}
 J_{i(T_g)} &= (IAE + \lambda ISU)_{T_g} + IAE_{EO_2} \\
 J_{i(EO_2)} &= 0 + IAE_{EO_2}
 \end{aligned}
 \tag{15}$$

Tables 4 and 5 compare the optimised PID parameters by the respective SGA tuning approaches of  $T_g$  and  $EO_2$ ,

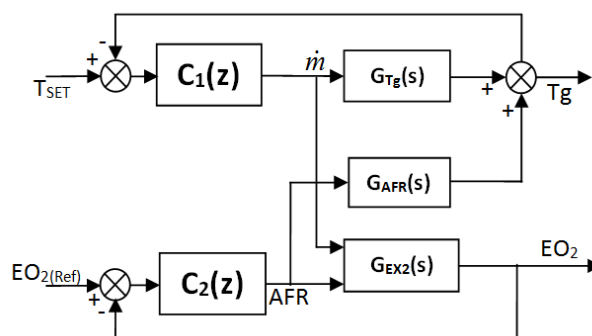

Figure 6 2-input, 2-output multivariable control oriented model under closed-loop discrete decentralised PID control

respectively. As discussed in section 2, any variation in  $\dot{m}$  by  $T_{SET}$  and  $EO_{2(Ref)}$  step inputs are represented in ratio of 1. Thus, Fig. 8 reveals that there is no change in  $EO_2$  responses by SGAs-1 and SGAs-2. This can also be noticed in Table 5, where the PID parameters for these two approaches barely have a change.

On the other hand, Fig. 7 reveals that the optimised PID parameters by SGAs-1 are inadequate to achieve the desired performance criterion of  $T_g$  under loop interaction. As a result of the  $G_{AFR}(s)$ 's long dynamic time constant (2e5 s), the  $T_g$  response rise time ( $t_r$ ) is lagged about 24min, hence the settling time ( $t_s$ ) has increased to 7hrs and produced a steady-state error of 1K. In contrast, the SGAs-2 method consolidated better with loop interaction and  $G_{AFR}(s)$ 's dynamic time constant to maintain the desired performance criterion by increasing the  $K_P$  and  $K_I$  parameters accordingly.

The SGAs-3 tuning approach is tested by applying step inputs on both set points ( $T_g$  and  $EO_2$ ) at two different time periods in one simulation with the modified (combined) cost function (14). Thus, the total simulation time has increased to optimise both sets of PID parameters. The simulation results of SGAs-3 for  $T_g$  are shown in Fig. 9. At  $t_1 = 0$ hrs;  $T_{SET} = 1500K \rightarrow 1550K$ ;  $EO_2 = 2.45\%$  (constant). At  $t_2 = 61.1$ hrs;  $T_{SET} = 1550K$  (constant);  $EO_2 = 2.45\% \rightarrow 3\%$ . From  $t_1$  to  $t_2$ , technically the cost function of  $T_g$  ( $IAE + \lambda ISU$ ) is optimising the PID parameters of  $C_1(z)$  individually without any effect of the  $EO_2$  cost function

6

Table 4 Optimised PID parameters for  $T_g$  by decentralised techniques

Tuning Approach	$K_c$	$K_I$	$T_d$	IAE+ $\lambda$ ISU	$t_s$ (%)
SGAs-1	9.863e-3	9.461e-6	7.358	7.029e4	4.9hrs
SGAs-2	1.052e-2	1.371e-5	7.211	7.017e4	4.86hrs
SGAs-3	1.108e-2	1.311e-5	7.892	7.007e4	4.84hrs

Table 5 Optimised PID parameters for  $EO_2$  by decentralised techniques

Tuning Approach	$K_c$	$K_I$	$T_d$	IAE	$t_s$ (%)
SGAs-1	0.7685	0.0043	32.27	187.7	7.1min
SGAs-2	0.7679	0.00427	32.84	188.9	7.1min
SGAs-3	0.7857	0.004313	32.18	178.53	6.9min

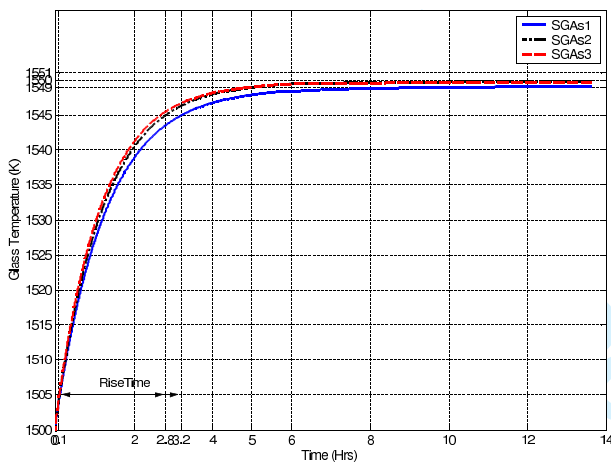

Figure 7  $T_g$  responses by three SGAs tuning approaches under loop interaction

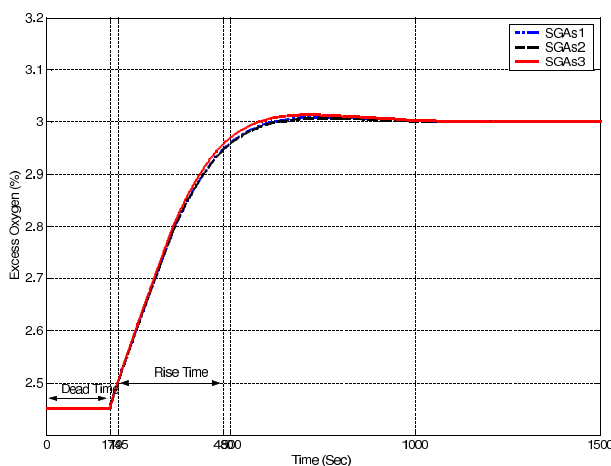

Figure 8  $EO_2$  responses by three SGAs tuning approaches under loop interaction

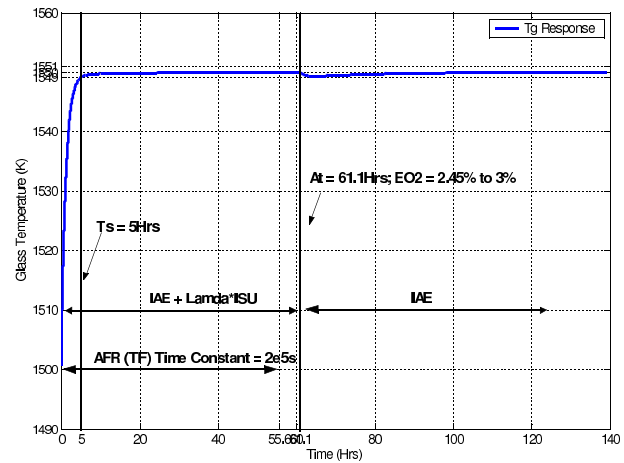

Figure 9  $T_g$  responses by SGAs-3 with modified (combined) cost function

(IAE). Such a long time gap between  $t_1$  and  $t_2$  is required in the optimisation considering the effect of  $G_{AFR}(s)$ 's long dynamic time constant ( $2e5$  s). Up to  $t_1$  there is no effect on  $EO_2$  as no loop interaction is cancelled by the AFR relationship inherent in the process.

From  $t_2$  the total effect of  $T_g$  and  $EO_2$  cost functions ( $J_i(T_g)$ ) are compound together in further optimisation of  $C_1(z)$  and  $C_2(z)$  PID parameters. According to the Fig. 9, the  $T_g$  is reduced approximately to 1549.2K under loop interaction for the increase in  $EO_2$  at  $t_2$ . To maintain the  $T_g$  response, the  $K_P$  parameter by SGAs-3 is increased about 5.31% from SGAs-2. But, the  $K_I$  parameter by SGAs-3 is reduced about 4.58% from SGAs-2. The effect of an increment and reduction of  $K_P$  and  $K_I$  is noticeable in Fig. 7 where both gain parameters are consolidating well to achieve a desirable response. Also, the  $EO_2$  response and PID parameters vary insignificantly with modified (combined) cost function ( $J_i(T_g)$ ) as illustrated in Fig. 8 and Table 5.

The total set-point error of  $J_i(T_g)$  is 7.0249e4. Technically, as there is no loop interaction from  $\dot{m}$  to  $EO_2$ , the cost function of  $J_i(EO_2)$  (15) is applied to identify the set-point error of  $EO_2$ . As a result, the set-point error of  $J_i(EO_2)$  is 178.53. Also the optimised PID parameters by  $J_i(T_g)$  for  $EO_2$  are very much similar to  $J_i(EO_2)$ . Thus, the set-point error of IAE +  $\lambda$ ISU( $T_g$ ) is 7.007e4 by calculation.



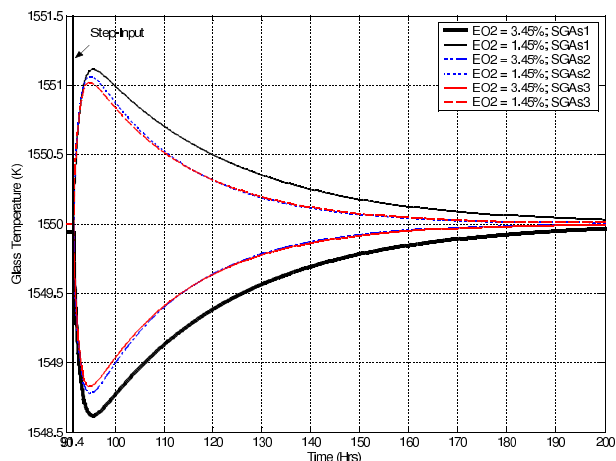

Figure 10 Loop interaction of multivariable process under closed-loop discrete decentralised control strategy. Effect of  $EO_2(\text{ref})$  ( $\Delta 1\%$ ) on  $T_g$ .

As discussed in section 2, a nonlinearity effect may appear in step input variations due to the methane chemical relationship of stoichiometric AFR(volumetric) with  $EO_2(\%)$ . Thus, the loop stability and control robustness are investigated further. Fig. 10 illustrates the robust responses of  $T_g$  for the three sets of optimised PID parameters (SGAs-1 to SGAs-3) under loop interaction for two  $EO_2$  step input tests. The simulations of the two  $EO_2$  step input tests are elaborated as follows;

- i.  $T_g = 1550\text{K}$  (steady state);  $EO_2, 2.45\% \rightarrow 3.45\%$ ; causes a reduction in  $T_g, 1550\text{K} \rightarrow 1548.7\text{K}$  (approximately).
- ii.  $T_g = 1550\text{K}$  (steady state):  $EO_2, 2.45\% \rightarrow 1.45\%$ ; causes an increase in  $T_g, 1550\text{K} \rightarrow 1501\text{K}$  (approximately).

The observed disturbances in  $T_g$  are caused by the changing AFR as a result of the  $EO_2$  set points. To compensate the feedback error, controller  $C_1(z)$  varies  $\dot{m}$  accordingly to sustain  $T_g$ . In overall, the SGAs-2 has 17.4% better control robustness than SGAs-1. While, the SGAs-3 has 4.36% better control robustness than SGAs-2.

## 5 Conclusion

According to the desired response characteristics, the control parameters optimisation by genetic algorithms is enhanced with an improved cost function and improved searching boundaries. The loop interaction and control robustness within the realistic multivariable glass furnace is compensated with well optimised PID parameters by SGAs in a decentralised PID control scheme.

## References

- [1] Scottish Environment Protection Agency (SEPA), "Guidance for Monitoring Enclosed Landfill Gas Flares", Report No. GEHO1104BHZI-E-P, 2005.
- [2] T.J. Monica, C.C. Yu and W.L. Luyben "Improved Multi-loop Single-Input/Single-Output (SISO) Controller for Mul-

tivariable Process", Ind. Eng. Chem. Res., vol. 27, pp. 969-973, 1998.

- [3] M. Hovd and S. Skogestad, "Sequential Design of Decentralised Controllers", Automatica, vol. 30 (10), pp. 1601-1607, 1994.
- [4] T.K. Lee, J. Shen and M.S. Chiu, "Independent Design of Robust Partially Decentralized Controllers", J. Process Control, vol. 11, pp. 419-428, 2001.
- [5] J. Lee, W. Cho and T.F. Edger, "Multiloop PI Controller Tuning for Interacting Multivariable Processes", Comput. Chem. Eng., vol. 22 (11), pp. 1711-1723, 1998.
- [6] H.P. Huang, J.C. Jeng, C.H. Chiang and W. Pan, "A Direct Method for Decentralised PI/PID Controller Design", J. Process Control, vol. 13 (8), pp. 769-786, 2003.
- [7] A.P. Loh, C.C. Hang, C.K. Quek and V.U. Vasnani, "Auto-tuning of Multi-loop Proportional-Integral Controllers using Relay Feedback", Ind. Eng. Chem. Res., vol. 32, pp. 1102-1107, 1993.
- [8] P. Grosdidier and M. Morari, "A computer aided methodology for the design of decentralised controllers," Comput. Chem. Eng., vol. 11, pp. 423-433, 1987.
- [9] N.L.V. Truong, H. Seungtaek, and M. Lee, "Analytical Design of Robust Multi-loop PI Controller for Multivariable Process," ICCAS-SICE Inter. Joint Conference, pp. 2961-2966, 2009.
- [10] D.E. Goldberg, "Genetic algorithms in search, optimisation and machine learning," 1st ed., Addison-Wesley, pp. 7-10, 1989.
- [11] P. Wang and D.P. Kwok, "Optimal design of PID process controllers based on genetic algorithms," Control Eng. Prac., vol. 2 (4), pp. 641-648, 1994.
- [12] P.K. Viswanathan, W.K. Toh and G.P. Rangaiah, "Closed-Loop Identification of TITO Processes Using Time-Domain Curve Fitting and Genetic Algorithms", Ind. Eng. Chem. Res., vol. 40 (13), pp. 2818-2826, 2001.
- [13] R. Bandyopadhyay, U.K. Chakraborty and D. Patranabis, "Autotuning a PID Controller: a fuzzy-genetic approach", J. Syst. Architect., vol. 47, pp. 663-673, 2001.
- [14] C. Vlachos, D. Williams and J.B. Gomm, "Genetic approach to decentralised PI controller tuning for multivariable processes," IEE Proc.-Control Theory Appl., vol. 146 (1), pp. 58-64, 1999.
- [15] D. Li, F. Gao, Y. Xue and C. Lu, "Optimisation of Decentralised PI/PID Controllers based on Genetic Algorithm", Asian Journal of Control, vol. 3 (3), pp. 306-316, 2007.
- [16] M.R. Rani, H. Selamat, H. Zamzuri and Z. Ibrahim, "Multi-Objective Optimisation for PID Controller Tuning using the Global Ranking Genetic Algorithm", Journal of Innovative Computing, Information and Control, vol. 8 (1A), pp. 269-284, 2012.
- [17] H.A. Morris, "Advanced modelling for small glass furnaces," Master's Thesis, Department of Mechanical Engineering, West Virginia University, Morgantown, USA, 2007.
- [18] A.R. Holladay, "Modelling and control of a small glass furnace," Master's Thesis, Department of Mechanical Engineering, West Virginia University, Morgantown, USA, 2005.

- [19] J. Gaffney, D.A. Green and C.E.M. Pearce, "Binary versus Real Coding for Genetic Algorithm: A False Dichotomy?", *Journal of Engineering Mathematics and Applications Conference*, vol. 51, pp. C347-C359, 2010.



Picture to be supplied and biography updated

**Kumaran Rajarathinam** is a PhD student researching Advanced Control Techniques with the Control Systems Group in the Mechanical Engineering and Materials Research Centre (MEMARC) at Liverpool John Moores University, UK.

E-mail:  
K.Rajarathinam@2011.ljmu.ac.uk



Picture to be supplied

**J. Barry Gomm** received the BEng(Hons) first class degree in Electrical and Electronic Engineering in 1987 and the PhD in process fault detection in 1991 from Liverpool John Moores University (LJMU), UK. He joined the academic staff at LJMU in 1991 and is a Reader in Intelligent Control Systems. He was co-editor of the book "Application of

Neural Networks to Modelling and Control" (London, UK: Chapman and Hall, 1993) and has been Guest Editor for several journal special issues including Fuzzy Sets and Systems and Transactions of the Institute of Measurement and Control. In 2011, Dr Gomm as co-author received the IFAC award for most cited paper in the journal Engineering Applications of Artificial Intelligence. He has published more than 130 papers in international journals and conference proceedings. Dr Gomm is a member of the IET and IEEE, and has served on an IET committee and organising committees of several conferences. His current research interests include neural networks for modelling, control and fault diagnosis of non-linear processes; intelligent techniques for control; system modelling and identification; adaptive systems and algorithms; analysis, control and stability of non-linear systems. Applications include automotive engines; chemical, biochemical and manufacturing industrial processes.

E-mail: j.b.gomm@ljmu.ac.uk (Corresponding author)



Picture to be supplied

**DingLi Yu** received B.Eng from Harbin Civil Engineering College, China in 1982, M.Sc from Jilin University of Technology (JUT), China in 1986, and the PhD from Coventry University, U.K. in 1995, all in Control Engineering. Dr. Yu was a lecturer at JUT from 1986 to 1990, a visiting researcher at University of Salford, U.K. in 1991, a post-doctoral research fellow at Liverpool John Moores University (LJMU) from 1995 to 1998. He joined LJMU Engineering School in 1998 as a Senior Lecturer and was promoted to a Reader in 2003, then to Professor of Control Systems in 2006. He is the associate editor of two journals, International Journal of Modelling Identification and Control and International Journal of Information & Systems Sciences. He organized two special issues in 2006, "Fault Detection, Diagnosis and Fault Tolerant Control for Dynamic Systems" and "Intelligent Monitoring and Control for Industrial systems". He serves as a committee member of the IFAC SAVEPROCESS Committee, and has been IPC member for many international conferences. He is a fellow of IET and Senior Member of IEEE. He leads the Control Systems Research Group at LJMU. His current research interests include fault detection and fault tolerant control of bilinear and nonlinear systems, adaptive neural networks and their control applications, model predictive control for chemical processes and automotive engines and real-time evaluations, in these areas he has published more than 160 journal and conference papers and these papers haven cited more than 580 times.

E-mail: d.yu@ljmu.ac.uk



Picture to be supplied and biography updated

**Ahmed Saad Abdelhadi** is a PhD student researching Nonlinear System Identification and Control with the Control Systems Group in the Mechanical Engineering and Materials Research Centre (MEMARC) at Liverpool John Moores University, UK.

E-mail: a.s.abdelhadi@2012.ljmu.ac.uk.