

Laser Induced Micro Plasma Processing of Polymer Substrates for Biomedical Implant Applications

P.W. French, A. Rosowski, M. Murphy, M. Irving, M.C. Sharp

Liverpool John Moores University, General Engineering Research Institute, Byrom St, Liverpool,
United Kingdom L3 3AF

ABSTRACT

This paper reports the experimental results of a new hybrid laser processing technique; Laser Induced Micro Plasma Processing (LIMP2). A transparent substrate is placed on top of a medium that will interact with the laser beam and create a plasma. The plasma and laser beam act in unison to ablate material and create micro-structuring on the “backside” of the substrate. We report the results of a series of experiments on a new laser processing technique that will use the same laser-plasma interaction to micromachining structures into glass and polymer substrates on the “topside” of the substrate and hence machine non-transparent material. This new laser processing technique is called Laser Induced Micro Plasma Processing (LIMP2).

Micromachining of biomedical implants is proving an important enabling technology in controlling cell growth on a macro-scale. This paper discusses LIMP2 structuring of transparent substrate such as glasses and polymers for this application. Direct machining of these materials by lasers in the near infrared is at present impossible. Laser Induced Micro Plasma Processing (LIMP2) is a technique that allows laser operating at 1064 nm to machine microstructures directly these transparent substrates.

INTRODUCTION

Lasers are increasingly being used for micromachining applications and one industrial sector that is seeing an increase in this activity is biomedical. An important class of materials are medical industrial grade polymers and these polymeric materials are machined using laser systems whose wavelength is absorbent to the polymeric system being machined. A new generation of near infra-red (NIR) fibre lasers have been developed and are used in micromachining of metals but polymers are proving problematical due to polymers lack of absorptivity in the NIR. In this paper we describe a new hybrid micromachining technique that allows NIR lasers to machine transparent polymers. This new technique uses laser generated plasma to machine the polymeric system. This novel micromachining technique is called Laser Induced Micromachining Plasma Processing, LIMP². LIMP² can machine opaque as well as transparent materials. We will now describe the LIMP2 process which is called *transmission* mode, where the laser material processing occurs on the front face of the micro-machined substrate, figure 1. To process in this configuration the following elements are required. A thin film that can support a thin layer of material that can absorb a laser beam. This thin absorbing layer produces a plasma when exposed to a focused laser beam. This layer can be made of either a metallic or organic material that is absorbent at the laser wavelength. The layer is positioned a few tens of microns from the substrate that is being processed. The laser beam vaporises the coating producing a plasma which in combination with the laser beam machines the surface of the substrate without depositing a coating on to the newly machined surface. So that the laser beam sees a new area of the coated film to create the plasma, the film is continuously rotated and translated during processing. This processing technique can be applied to materials that are normally impossible to process solely with a laser, either due to the lack of absorption by the substrate or due to its high ablation threshold. LIMP² is a unique laser processing technique and this novel aspect of the technique constitutes a risk to the success of the project as it goes against the normal tenet of

laser material processing, namely that of placing material in the path of the laser beam. This is the probable reason why other international research groups have failed to investigate processing in transmission mode.

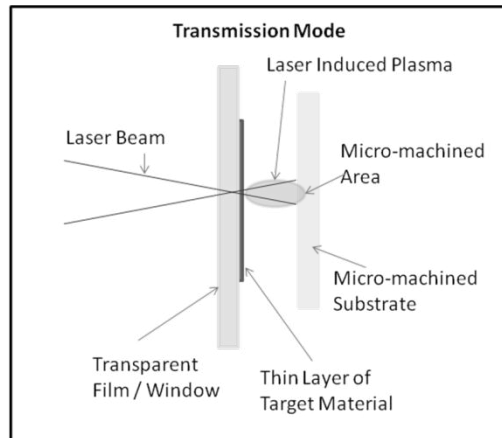

Figure 1 Transmission mode Laser Induced Microplasma Processing

STATE OF THE ART.

A review of the literature has revealed a similar ablation assisted technique given the name of Laser Induced Plasma Assisted Ablation (LIPAA), which in turn has spawned two other variations of this plasma assisted laser processing technique. LIPAA was first developed by Zhang et al [1 – 3] at RIKEN in Japan. The experimental setup for LIPAA is similar to LIMP² in reflective mode. A laser source illuminates a stencil metal mask that carries the pattern to be machined into the transparent substrate. The laser beam is focused through the transparent substrate onto a metallic target positioned between zero to a few millimetres behind the rear surface of the substrate. The combination of both the laser beam and the laser induced plasma has sufficient energy to micro machine the surface of the transparent substrate. Zhang suggested an ablation mechanism for LIPAA. Zhang recognised that the ablation mechanism is complicated and requires clarification.

Wang et al [4 - 5] then introduced a similar hybrid laser processing technique call Laser Induced Backside Wet Etching (LIBWE). This laser processing technique is very similar to LIPAA. It has the same elements as LIPAA except that the target is no longer a solid metallic target but has been replaced with a liquid, namely pyrene in acetone solution. Wang used a XeCl excimer laser at a wavelength of 308 nm. Wang suggested a mechanism for LIBWE based on experimental observations. Pyrene molecules in the organic solution repeatedly absorbed many photons within a pulse by cyclic multi-photon absorption and released an enormous amount of heat to the organic solution by rapid internal conversion which in turn generated a superheated liquid. The liquid not only heated the surface of the fused silica but also attacked the softened surface with a high temperature pressure vapour. As a result clusters of SiO₂ are removed from the bulk material. Wang used LIBWE to process optical materials quartz crystal and fused silica,

Pissadakis et al [6] applied the processing technique to sapphire and produced optical gratings. The third group within RIKEN to study material processing of LIPAA was Sugioka et al [7] and Hanada et al [8]. Sugioka's work is of interest because in his paper he refers to results where he has micro-machined fused silica in a direct writing mode similar to LIMP² in reflective mode. The laser beam was scanned over the surface of the target material that produces the plasma using an X Y galvanometer system. Using LIPAA in this mode he demonstrated laser cutting and micromachining of fused silica. Hanada applied LIPAA to polyimide, a polymeric material. Using LIPAA in mask projection mode, Hanada micro-machined channels into the polyimide which were later metal plated using an electroless plating solution for

selective metallisation. In this manner he laid down conductive tracks. Hamada's group is the only one that has used the new processing technique on a polymeric material.

Lately research into laser induced plasma processing has taken place mainly in Europe [9 – 14]. The main development introduced by these European groups has been in the configuration of the target material that produces the plasma. Bohme et al [9] exchanged the bulk liquid target used in LIBWE with a thin film of liquid based on the members of the benzene family. The process was called Laser Etching at a Surface Absorbed Layer, (LESAL). Again the technique was used in a projection mode through a mask with structures being produced in fused silica. Hopp, [10, 11, 14], Kopitkovas [12] and Ihlemann also developed a variation on the LIPAA processing technique. Hopp introduced, initially a thin film of carbon which he later replaced with a thin metallic layer. This technique was called Laser Induced Backside Dry Etching (LIBDE). The plasma was formed at the interface between the transparent substrate and the metallic layer. Hopp showed that the removal rate of material was more efficient using LIBDE than the LIPAA technique.

EXPERIMENTAL SET-UP

The laser used in the experiments was a SPI 20W G3.0 pulsed fibre laser in combination with Cambridge Technology galvanometer scanning optics. A schematic of the experimental set up can be seen in figure 2. The laser beam from the SPI laser system was delivered through an optical fibre to the scanning optics. An expanding telescope was used to expand the laser beam to 10 mm which was then directed down on to the micro-machine polymeric substrate. The laser beam was focused onto the workpiece using a F-Theta lens with a focal length of 100 mm. The laser beams focal spot diameter was 30 μm .

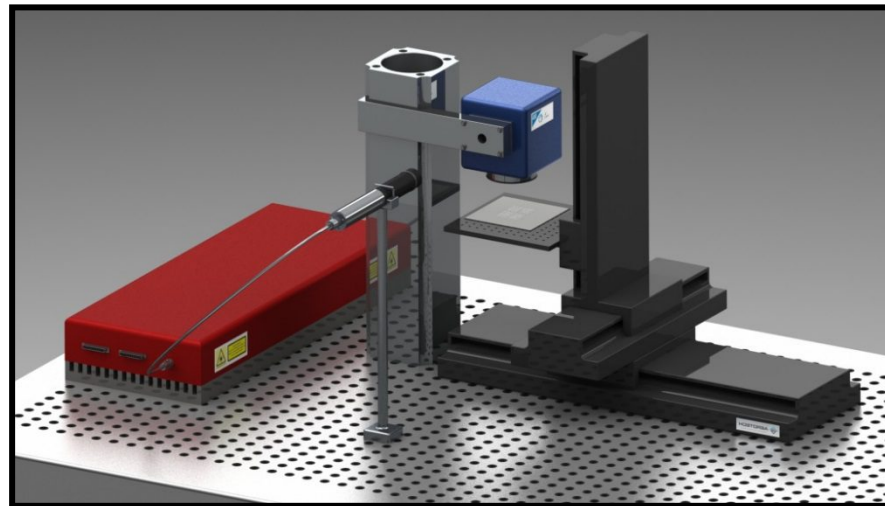

Figure 2. Schematic view of the experimental set up.

The polymer system used in these experiments were supplied by Biomer Technology Ltd. The polymer was coated on the bottom of a glass cell culturing dish and cured in an oven for approximately two hours until all of the solvents were driven off.

LIMP² took a major departure in its selection of plasma producing material compared with the other laser-plasma processing techniques developed and discussed in the previous section. Instead of coating the LIMP² processing sides with a hydrocarbon we initially selected a metal, in this case, aluminium. For these particular experiments we developed a coating technique that allowed us to coat glass slides with metals and non-metals such as graphite.

The coating procedure consists of first cleaning the slide with an alcohol based agent. Once the slide is clean a small droplet of the cleaning agent is deposited onto the slide, at which point, an aluminium foil previously cut to size is pressed to the surface of the slide so that the droplet of fluid is worked to the edge of the slide. The aluminium foil is then held in contact with the slide through capillary action. The foil now in contact with the glass slide is then laser processed using the following parameters: 20 W, 125 kHz, 30 ns pulse length and a hatch of 50 μm . These parameters transfer the aluminium foil to the glass slide as an aluminium oxide coating Figure 3. These coated slides are used as LIMP² processing tools for machining both glass and polymer substrates.

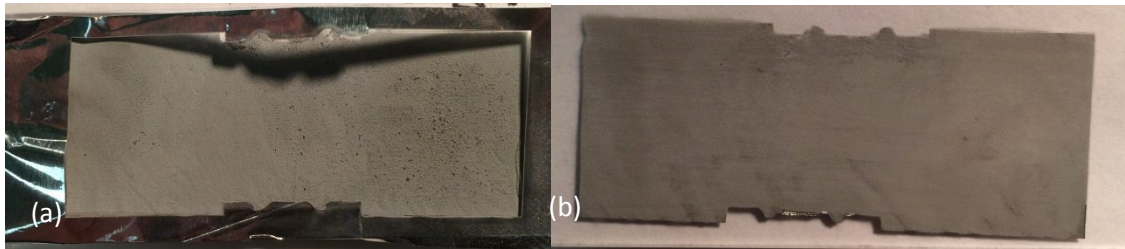

Figure 3. Coated LIMP² slides used as plasma processing tools (a) with foil (b) foil removed

RESULT AND DISCUSSION

The distribution of the dimensions of the features produced using the LIMP² process for both the height and width can be seen in figure 5, 6, 7 and in figure 8. In tables 1 and 2 the mean height values are given for each set of data measured for a particular surface. The mean values for the width of the features are given in table 3 and 4. Image analytical software JIMAGE was used to produce the tables and bar graphs of the height and width data. The data distribution within the histograms show that for both positions of the LIMP² processing tool above the micro-machined substrate, 80um and 160 um above the polymer, at both heights, features sizes less than 500nm were produced, figure 4 and 5.

Table 1: Height data: 20W 125kHz 30ns hatch 30um scan speed 500mm stand-off 80um

X Profile	Mean Value	Exp. Error	Y Profile	Mean Value	Exp. Error
Set 1	1762.1	± 141.6	Set 5	1298.2	± 122.7
Set 2	1698.3	± 225.4	Set 6	1733.7	± 174.6
Set 3	1540.5	± 207	Set 7	1886.3	± 313.2
Set 4	1350	± 243.7	Set 8	1279.2	± 242

Table 2: Height data: 20W 125kHz 30um Hatch 30um scan speed 500 mm/sec stand-off 160um

X Profile	Mean Value	Exp. Error	Y Profile	Mean Value	Exp. Error
Set 1	971.6	± 96.2	Set 5	1066.4	± 105.6
Set 2	1013.1	± 127.4	Set 6	1097.7	± 125.9
Set 3	1155.5	± 146.2	Set 7	1091.9	± 129.3
Set 4	695.2	± 73.6	Set 8	591.5	± 104.7

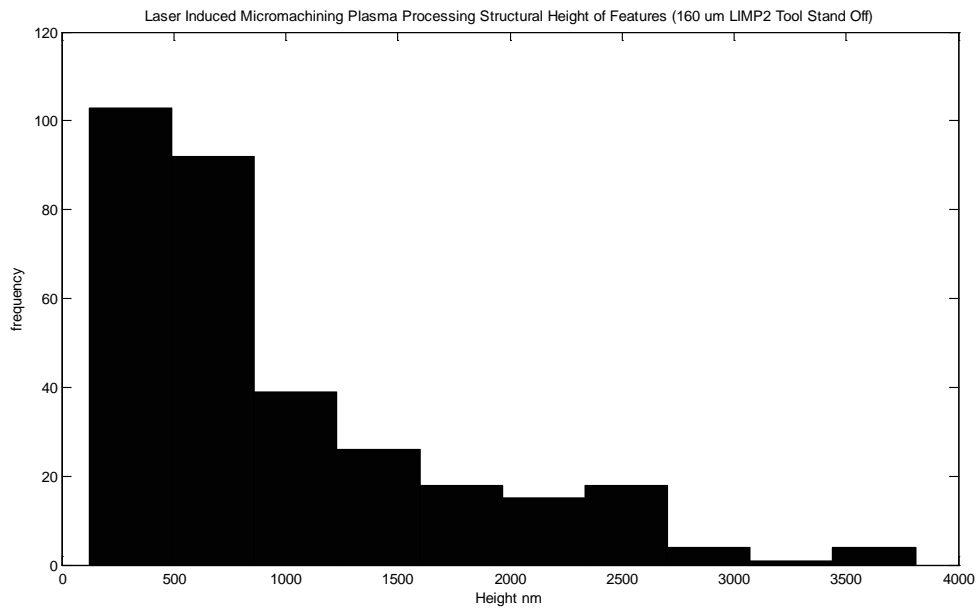

Figure 4. Histograms showing the distribution of height of features produced using a LIMP2 tool stand-off 80 μm

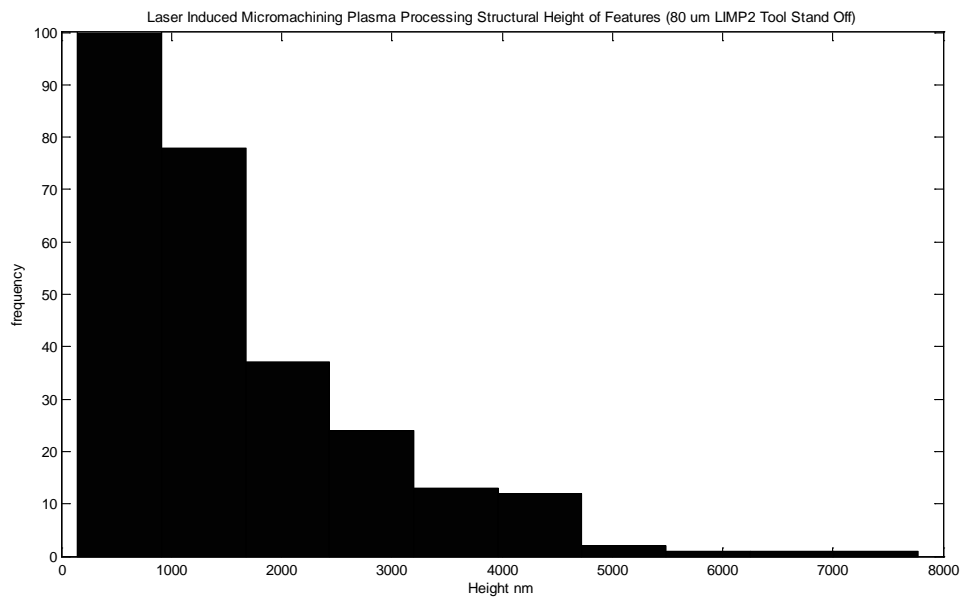

Figure 5. Histograms showing the distribution of height of features produced using a LIMP2 tool stand-off 160 μm

Taking the height data first, we see that for both LIMP2 tool stand-offs, the data is skewed towards the 1 μm or less feature size. The data set from the 160 μm tool stand-off shows that all the features created had a structural height that was less than 4 μm. The shorter stand-off distance of 80 μm produces features that extend out to 8 μm, though the population at these higher dimensions are small compared with the rest of the population in the distribution. The reasoning for this difference in the two distributions in the height data, we believe is due to the plasma intensity at the

plasma – polymer interface. As the plasma expands towards the surface of the polymer film it cools therefore the plasma processing of the polymer is less aggressive at a LIMP2 tool stand-off of 160um.

The widths of the structures again show a skew distribution, figure 6 and figure 7. For the 80µm tool stand-off the widths were centred around 10µm while for the 160µm it was centred on 5µm. It was observed that the smaller features were produced at the greater tool stand-off with the 80 um stand-off show a broader distribution than the 160 um stand-off. It is noticeable that processing with the LIMP2 tool at 80 µm the width of the features produced were greater than the 30 µm spot diameter. This would indicate that, at the shorter stand-off and processing with the more aggressive plasma interaction with the polymer surface, features larger than the laser spot diameter were produced. The data from the 160 µm tool stand-off on the other hand produced no features greater the laser beam spot diameter.

This would seem to indicate that, at the shorter LIMP2 tool distance of 80 um and at the higher plasma intensity interaction, the plasma processing area over the surface of the substrate is larger than the processing intensity of the laser beam. This would suggest that the plasma profile at 80 um stand-off can become larger than the laser spot diameter but from the distribution of the data we see that this event occurs infrequently but can produce structures that are larger than the spot diameter or hatch spacing of 30 um.

Table 3: Width data: 20W 125 KHz 30ns hatch 30um scan speed 500mm stand-off 80um

X Profile	Mean Value	Exp. Error	Y Profile	Mean Value	Exp. Error
Set 1	21.2	± 2	Set 5	21.8	1.3
Set 2	11.9	± 0.7	Set 6	9.8	0.6
Set 3	7.3	± 0.6	Set 7	5.6	0.5
Set 4	3.1	± 0.2	Set 8	3.5	0.4

Table 4: Width data: 20W 125 kHz 30um Hatch 30um scan speed 500 mm/sec stand-off 160um

X Profile	Mean Value	Exp. Error	Y Profile	Mean Value	Exp. Error
Set 1	11.1	± 0.6	Set 5	15.4	± 1.5
Set 2	5.4	± 0.4	Set 6	4.9	± 0.5
Set 3	5.6	± 0.4	Set 7	7.1	± 0.7
Set 4	0.9	± 0.2	Set 8	0.9	± 0.3

The data from the 160 um stand-off shows that the features produced never achieve a structural dimension greater than the hatch spacing of 30 um. At the greater LIMP2 tool distance the structures seem to be confined to the laser beam spot size of 30 um, that the plasma intensity is only affective within this area. At the shorter tool distance and greater plasma intensity, the plasma, can machining outside the confines of the laser beam and create larger structures. This would indicate that at the larger stand-off distance the LIMP2 process is more stable.

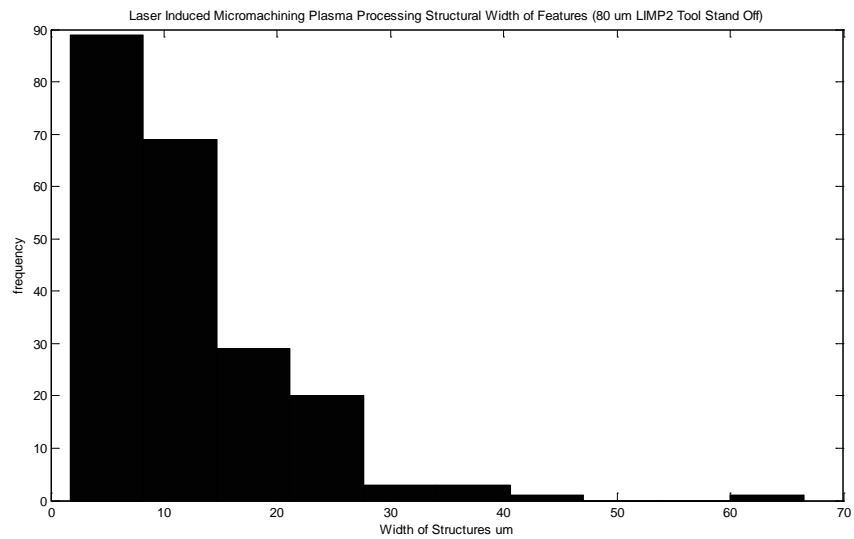

Figure 6. Histograms showing the distribution of widths of features produced using a LIMP2 tool stand-off 80 μm

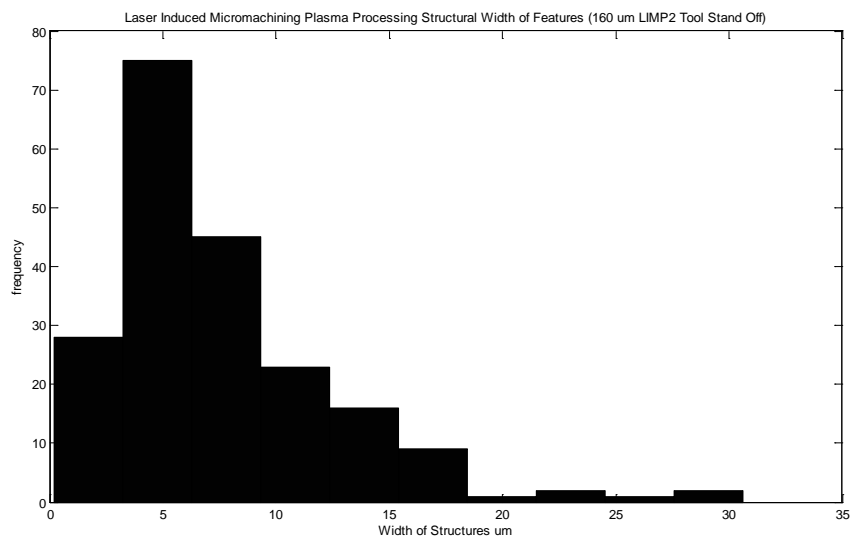

Figure 7. Histograms showing the distribution of widths of features produced using a LIMP2 tool stand-off 160 μm

Typical structures produced are shown for both the 80 μm and the 160 μm stand-off in figure 8 and figure 9 respectively.

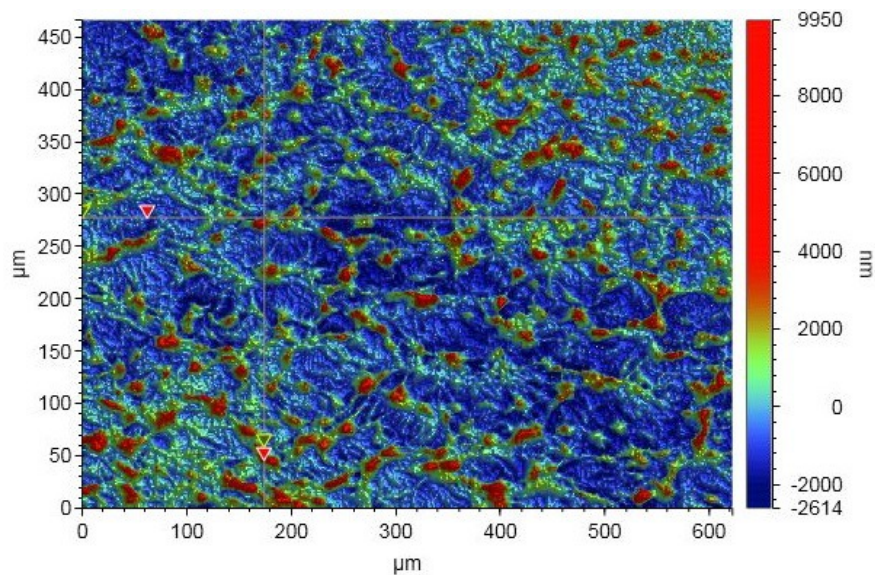

Figure 8 Typical surface topography produced by LIMP2 with an 80 μm LIMP2 tool stand off

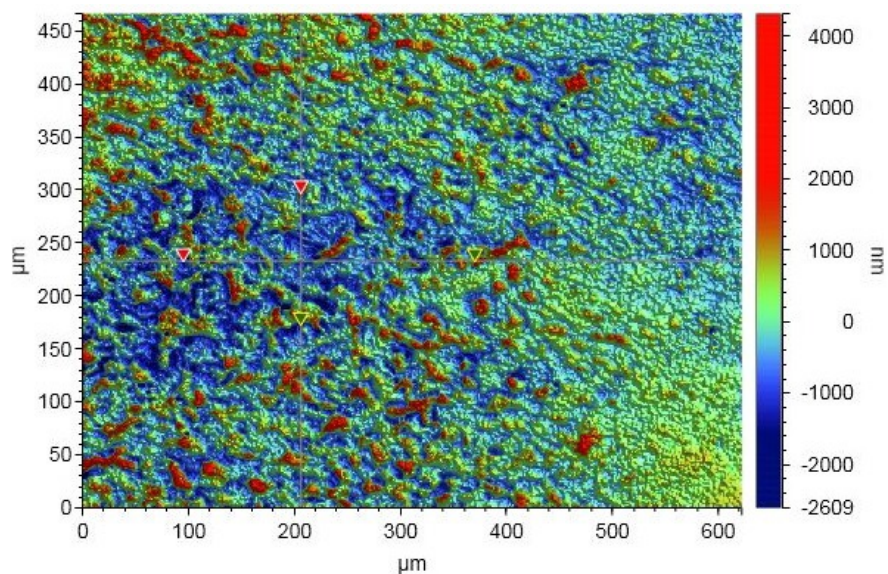

Figure 9. Typical surface topography produced by LIMP2 with a 160 μm LIMP2 tool stand off

CONCLUSION

In this paper we show the potential of a novel laser hybrid process technique, Laser Induced Micro Plasma Processing (LIMP²). The primary application field for this technique is functionalisation of polymeric surfaces that have poor absorptivity with respect to IR laser radiation. LIMP² allows the functionalisation of polymeric surfaces for biomedical or biomedical sensor applications. The structural scale of the structures produced have a distribution of that range below 500 nm up to 8 μm with respect to height and 500 nm by to the spot size of the laser beam 30 μm with respect to width. This figure are dependent on the LAMP2 tool stand-off, 160 μm giving the smaller feature size.

ACKNOWLEDGEMENTS

The authors acknowledge the support of the EPSRC in the development to the LIMP² process under their grant reference EP/J013242/1

REFERENCES.

- [1] Zhang.J, Sugioka.K, Midorikawa.K. Laser-induced plasma-assisted ablation of fused quartz using the fourth harmonic of a Nd⁺:YAG laser. *Applied Physics A, Material Science and Processing*, 67, pages 545 – 549. (1998).
- [2] Zhang.J, Sugioka.K, Midorikawa.K. High-speed machining of glass materials by laser induced plasma-assisted ablation using a 532-nm laser. *Applied Physics A, Material Science and Processing*, 67, pages 499 – 501. (1998).
- [3] Zhang.J, Sugioka.K, Midorikawa.K. High-quality and high-efficiency machining of glass materials by laser-induced plasma-assisted ablation using conventional nanosecond UV, visible and infrared lasers. *Applied Physics A, Material Science and Processing*, 69, [Suppl.] pages S879 - S882. (1999).
- [4] Wang.J, Niino.H, Yabe.A One step microfabrication of fused silica by laser ablation of an organic solution. *Applied Physics A, Material Science and Processing*, 68, pages 111 – 113. (1999).
- [5] Wang.J, Niino.H, Yabe.A. Micromachining of quartz crystal with excimer lasers by laser-induced backside wet etching. *Applied Physics A, Material Science and Processing*, 69,[Suppl] pages S271 – S273. (1999).
- [6] Pissadakis.S, Bohme.R, Zimmer.K. Sub-micro periodic structuring of sapphire by laser induced backside wet etching technique. *Optical Express*. No 4, Vol 15 Feb 2007. Pages 1428 – 1433.
- [7] Sugioka.K, Obata.K, Hong.M.H, Wu.D.J, Wong.L.L, Lu.Y.F, Chong.T.C, Midorikawa.K. Hybrid laser processing for microfabrication of glass. *Applied Physics A, Material Science and Processing*, 77, pages 251 - 257. (2003)
- [8] Hanada.Y, Sugioka.K, Takase.H, Takai.H, Miyamoto.I, Midorikawa.K. Selective metallisation of polyimide by laser induced plasma assisted ablation. *Applied Physics A, Material Science and Processing*, 80, pages 111 - 115. (2005)
- [9] Bohme.R, Zimmer.K, Ruthe.D, Rauschenbach.B. Backside etching at the interface to diluted medium with nanometer etch rates. *JLMN-Journal of Laser Micro/Naonengineering*. Vol 1,No 3, (2006)
- [10] Hopp.B, Vass.Cs, Smausz.T, Bor.Zs. Production of submicrometre fused silica gratings using laser induced backside dry etching technique. *Journal of Applied Physics D*. 39, pages 4843 – 4847, (2006)
- [11] Hopp.B, Vass.Cs, Smausz.T. Laser induced backside dry etching of transparent materials. *Applied Surface Science*. 253, pages 7922 – 7925. (2007)
- [12] Kopitkovas.G, Lippert.T, Venturini.J, David.C, Wokaun.A. Laser induced backside wet etching: Mechanism and Fabrication of Micro-Optical Elements. *Journal of Physics, Conference Series*, 59, pages 526 – 532, (2007)
- [13] Ihlemann.J. Micro patterning of fused silica by laser ablation mediated by solid coating absorption. *Applied Physics A, Materials Science & Processing*. 93, pages 65 – 68, (2008)
- [14] Hopp.B, Smausz.T, Csizmadia.T, Budai.J, Oszko.A, Szabo.G. Laser induced backside dry etching: Wavelength dependence. *Journal of Physics D. Applied Physics*, 41, (2008)